

TOTO LINK

The Smartest Network Device

AI Conference Camera



Integrated high-definition camera, microphone, speaker, DSP audio processing chip.

M1

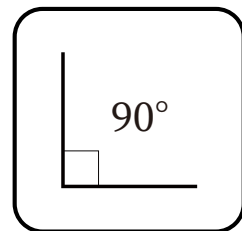

90° ultra wide
field of view



2K HD
Camera

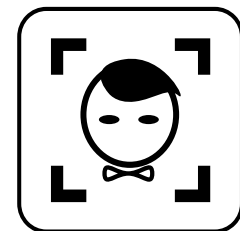

AI face
detection

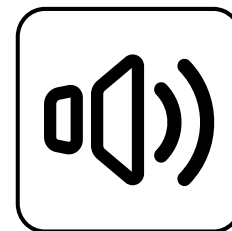

Built-in
speaker



4 array
microphones



5m Pickup
distance

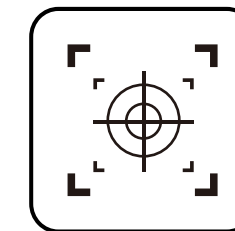

Auto-Framing

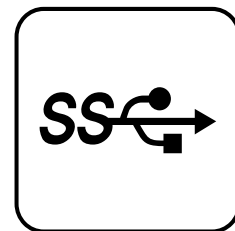

Drive-free USB

Overview

TOTOLINK M1 is portable all-in-one AI Conference Camera designed for small or midsize meeting rooms, which integrates features of microphone, speaker, and DSP audio. With built-in 2K HD camera with Auto-Framing, horizontal 90° view, M1 makes every seat at the table clearly visible.

The internal omnidirectional microphone picks up sound at 360°.

Benefit from automatic gain control(AGC), sounds within a radius 5 meters circle can be clearly collected.

USB plug & play, and a three-step setup make a quick video conference deployment. Its built-in DSP echo cancellation chip greatly reduced background noise interference on sound quality.

Compatible with Windows 7/8/10, Android, Apple, Ubuntu and other systems, M1 also works with most video chat or conferene applications, such as ZOOM, SKYPE, QQ, WeChat, Google Meet, Microsoft Teams, WebEx, Fastmeeting, ZHUMU , Polycom and etc.

Features

- HD color CMOS, 4 megapixel, UHD 2K@30fps resolution
- Privacy protection cover for camera lens.
- Support AI Technology for Face Detection.
- face detection Auto-Framing function.
- High-quality four-MIC design, sound pickup radius up to 5 meters.
- Built-in high-power speaker.
- 90° ultra-wide viewing angle ensuring everyone to be seen during the call.
- 360° omnidirectional microphone with best pickup diameter 10 meters.
- USB drive-free, compatible with Windows / Android / iOS / Linux operating systems.
- Compatible with mainstream video chat and video conference softwares or applications.
- With tripod, supporting 360°horizontal and 15° vertical rotation.



Highlights

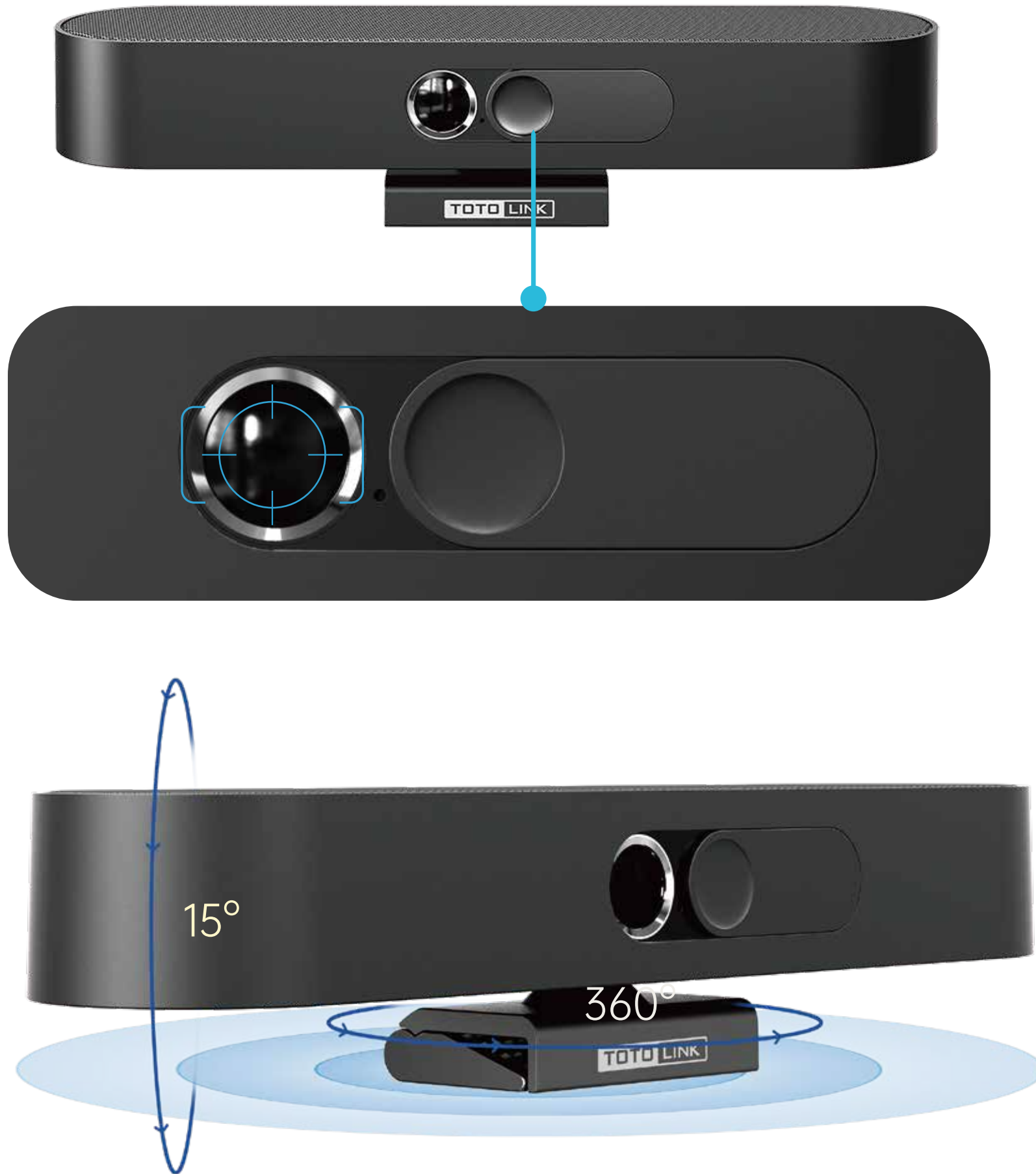

All-in-one Design

Integrated with HD camera, microphone, speaker, DSP audio processing chip.

Camera Lens Cover for Privacy Protection

Support Auto Dark function (auto night mode). When camera lens is covered, the image becomes all black with no light penetration. Your privacy is well protected.

Auto-Framing

Support auto face detection and auto focus.

Adjustable Base

15° Vertical, 360° Horizontal, in which horizontal adjustable needs to be realized with tripod.

Highlights

Method One

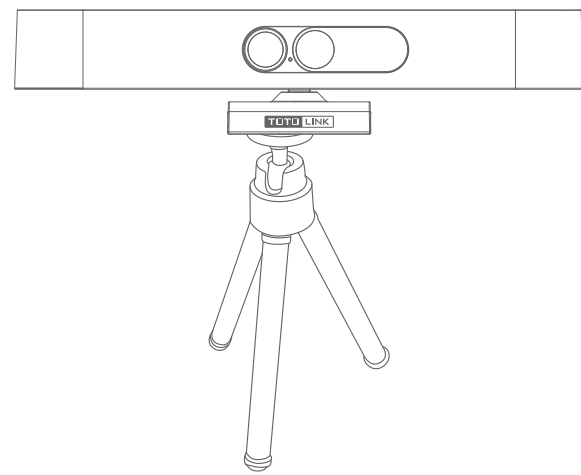

Mount with tripod
(tripod will be given as a gift)

Method Two

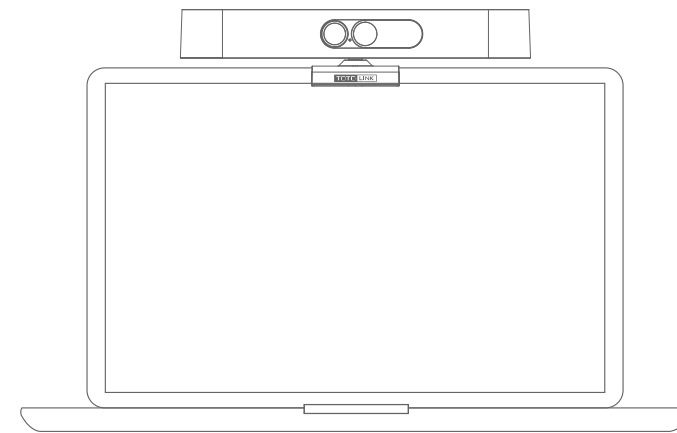

Mount with laptop

Method Three

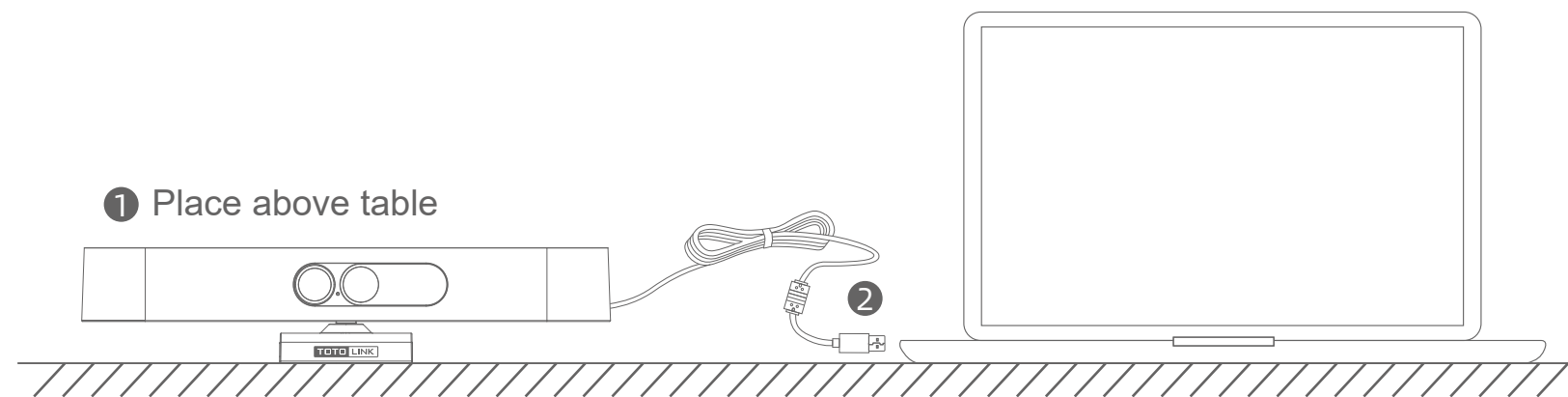

Easy Installation

Adjustable base, suitable for 0.5-5cm thick screen, with 1/4-20UNC screw holes at the bottom, and a silicone pad design close to the screen to prevent scratching the display.

Easy Set-Up

- ① Mount
- ② Connect USB directly to the PC or TV

High Performance Intelligent DSP Chip

Built-in DSP chip has full-duplex echo cancellation, dynamic noise suppression and other voice processing technologies.



Highlights



Built-in speaker

Built-in high-power speakers with AGC automatic gain control, brings clear sound.

Acoustic Echo Cancellation, Noise Reduction

Acoustic echo cancellation can detect the echo automatically and filter the echo when microphone pickup sound to make sure the meeting audio clear and stable. Noise reduction can effectively reduce the influence of ambient sound on video conference. In noisy environments, it can automatically filtered(reduced) ambient sound to ensure the meeting is clear.



Small Space with Ultra-wide View

The 90° ultra-wide view catches all details of the meeting.

Strong compatibility

Compatible with Windows, Android, iOS, Ubuntu and etc. Supports various video applications.



Specifications

Model : AI Conference Camera M1

Camera Resolution : 2K@30fps, 1080P@30fps, 720P@30fps
and other common resolutions Support 4:3
or 16:9 and other common aspect ratio output

Effective Pixels : 4 megapixel

Wide Angle : 90°

Microphones : 4 MIC array microphones

Loudspeaker : High-power loudspeaker, AGC automatic gain

Pickup Distance : Radius Up to 5M

Horizontal Rotation : With tripod, 360° horizontal rotation

Vertical Rotation : 15° vertical rotation

Interface : 1*USB2.0

Button : 1*Auto-Framing grab ON/OFF/LOCK

1*Protection cover for camera lens ON/OFF

LED Indicators : Red ON: Standby; Green ON: Normal operation

Usage Scenarios : Corporate video conferences,
remote recruitment, business negotiations,
computer cameras, TV cameras, USB audio
and video transmission, music play, etc.

Application area : 30m²

Maximum Power Consumption : < 3W

Size : 230mm * 75 mm * 40 mm

Weight : 420g

Color : Silver or black (optional)

Product Warranty : 1 year

Working Environment :

Normal working temperature : -30°C to 55°C

Maximum operating temperature : - 40°C to 70°C

Storage temperature : - 40°C to 70°C

Humidity : 5% ~ 95% (non-condensing)

ZIONCOM (HK) TECHNOLOGY LIMITED

Copyright©ZIONCOM (HK) TECHNOLOGY CO., LTD. All Rights Reserved.

Headquarter & R&D Center

7/F, Unit D, 4 Building Shenzhen Software Industry Base, Xuefu Road,
Nanshan District, Shenzhen, Guangdong, China

Tel : +86-755-3686-1138 | FAX : +86-755-3686-1139

Factory

Building A1 & A2 Lantian Technology Park, Xinyu Road, Xinqiao Henggang Block,
Shajing Street, Baoan District, Shenzhen, Guangdong, China

Tel : +86-755-3686-1188 | FAX : +86-755-3686-1133